

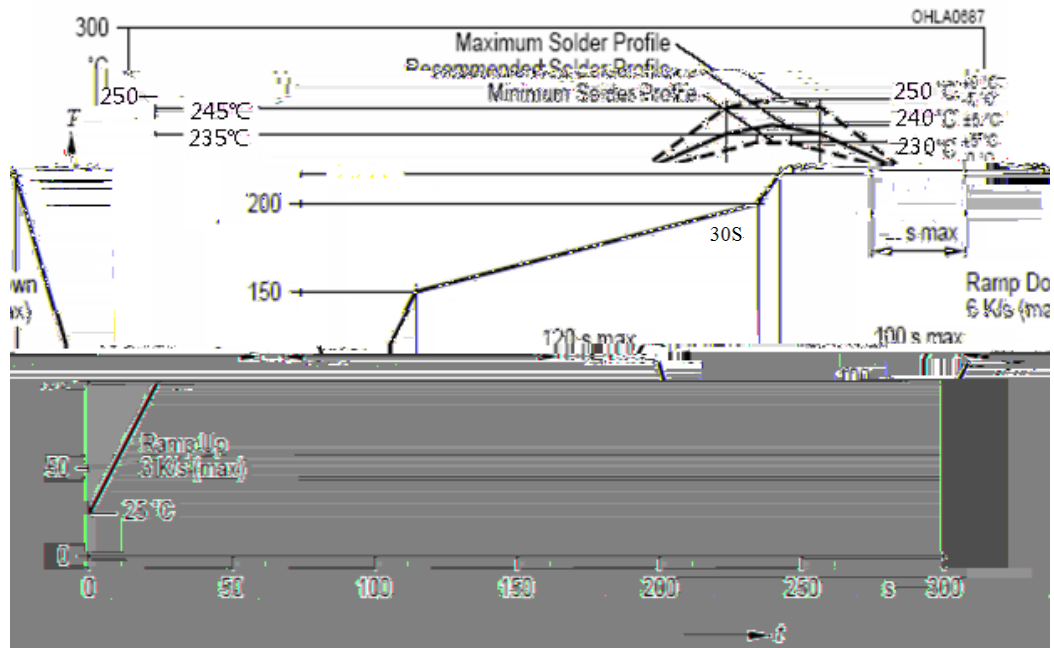

Suggest IR Reflow Condition For Lead Free:



Typical Electrical / Optical Characteristics Curves (25°C Ambient Temperature Unless Otherwise Noted)

Coupling Characteristics

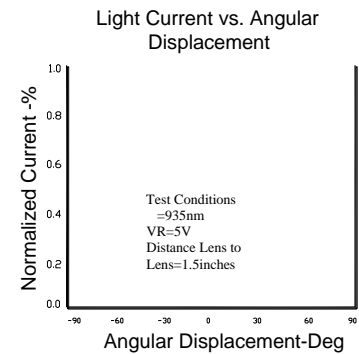
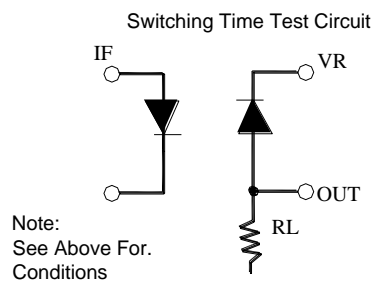
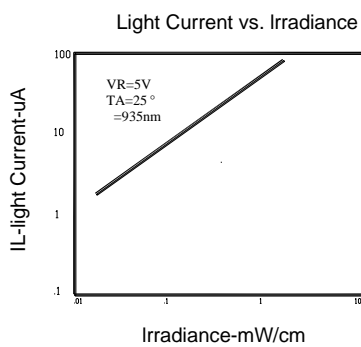
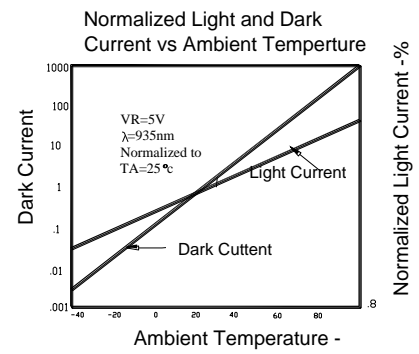
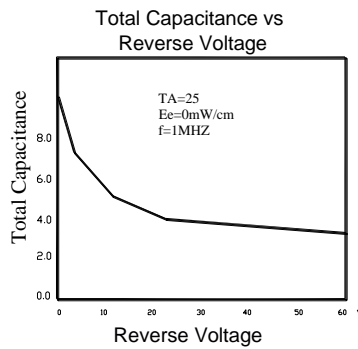
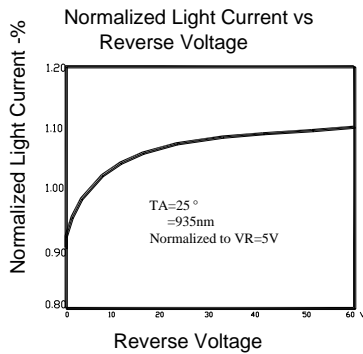
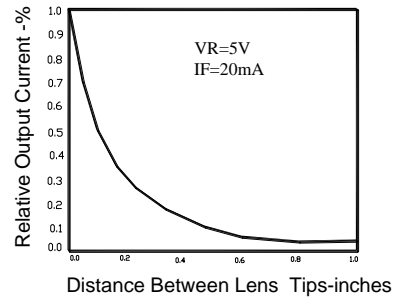

Package

Package Dimensions

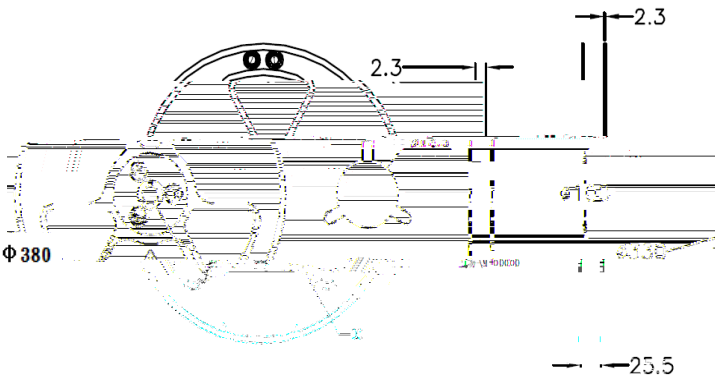
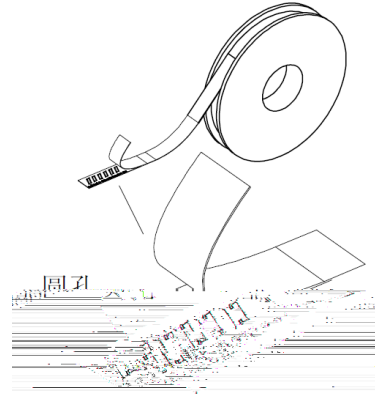
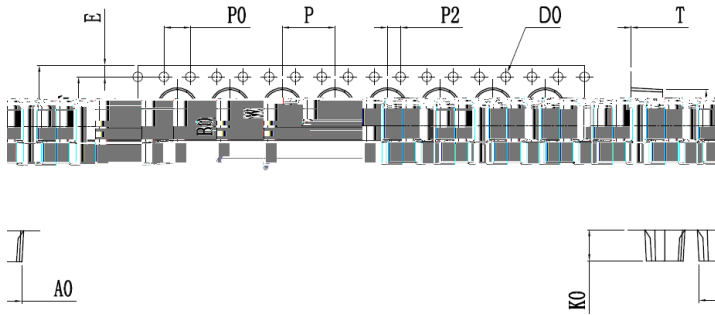

Item	Specification	
	Minimum	Maximum
W	15.97	16.3
P	7.9	8.1
E	1.65	1.85
F	7.4	7.6
D	1.5	1.6
P0	3.9	4.1
P0x10	39.8	40.2
P2	1.9	2.1
A0	5.2	5.4
B0	10.6	10.8
K0	4.8	5.0

Notes:

- 1.All dimensions in millimeters.
- 2.All dimensions meet EIA-481-C requirements.
- 3.Cover tape by a heat sealing manner.

LIGHT