





Parameter	MAX.	Unit
Power Dissipation	100	mW
Collector-Emitter Voltage	30	V
Emitter-Collector Voltage	5	V
Collector Current	50	mA

Moisture Sensitivity Level<sup>\*1</sup>

4

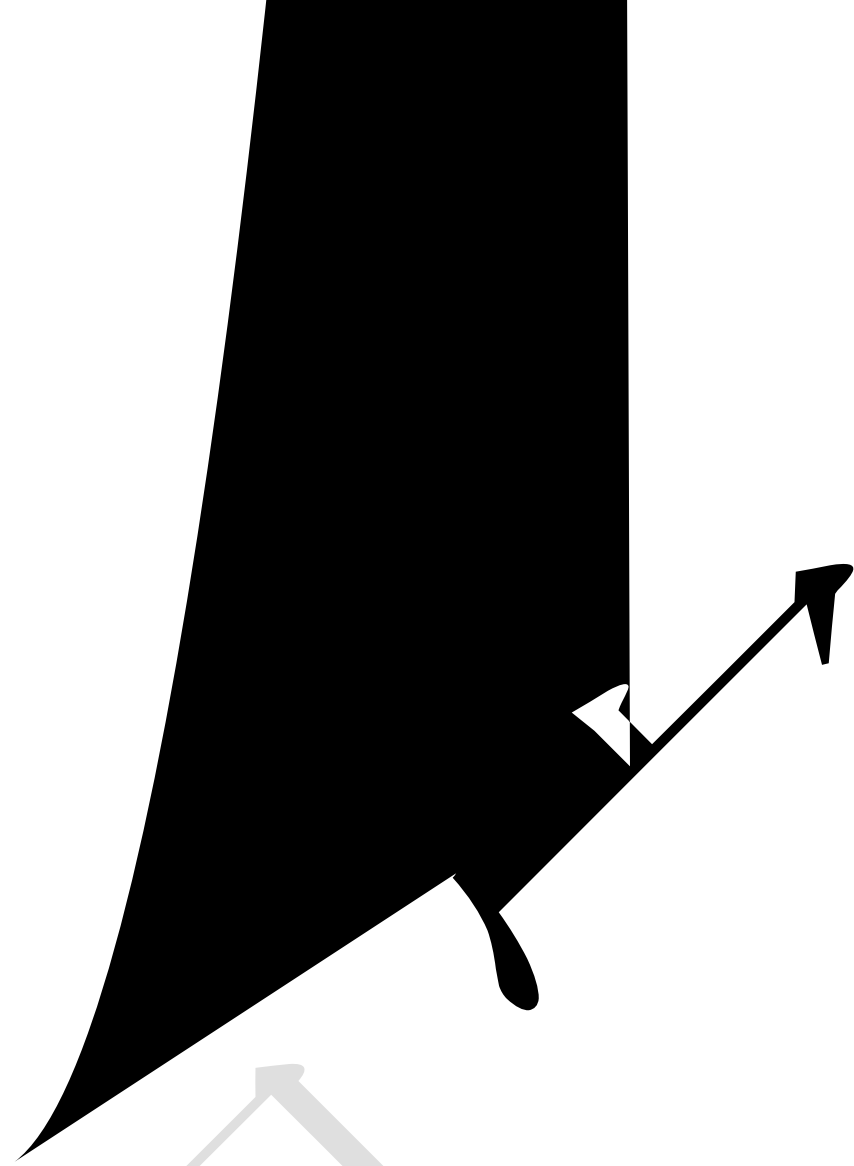

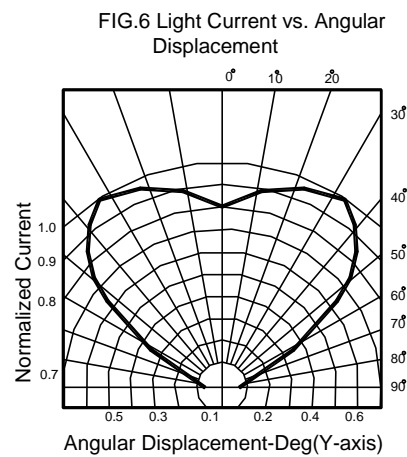
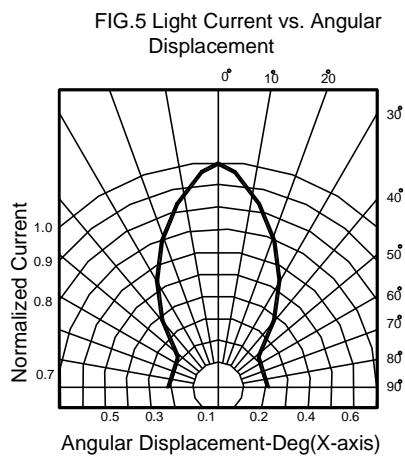
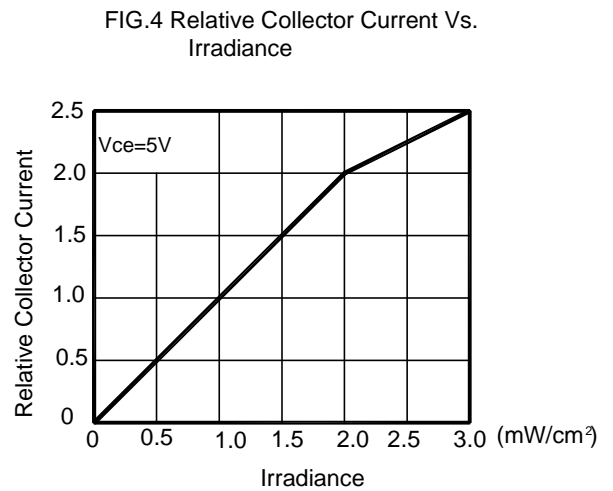
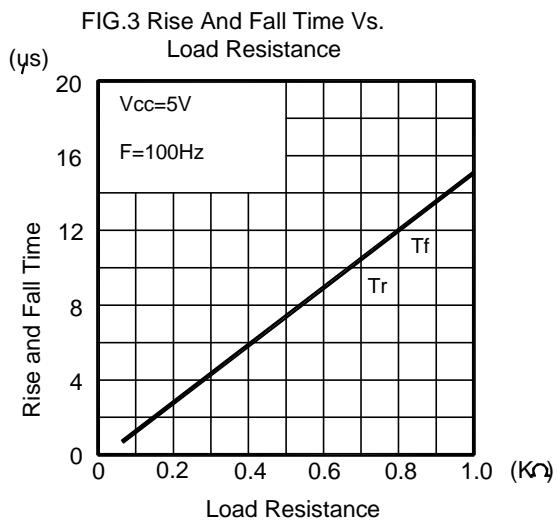
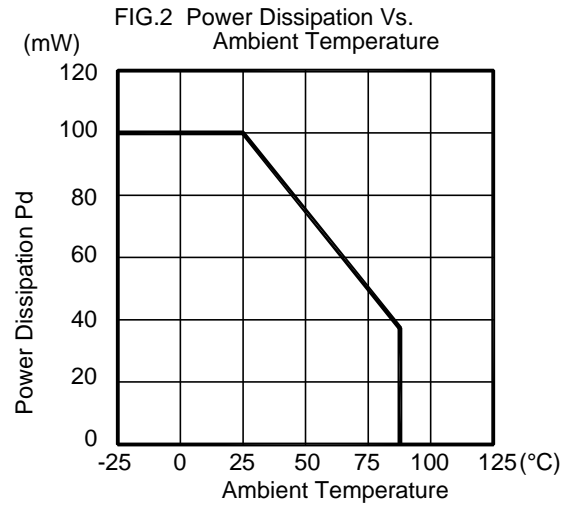
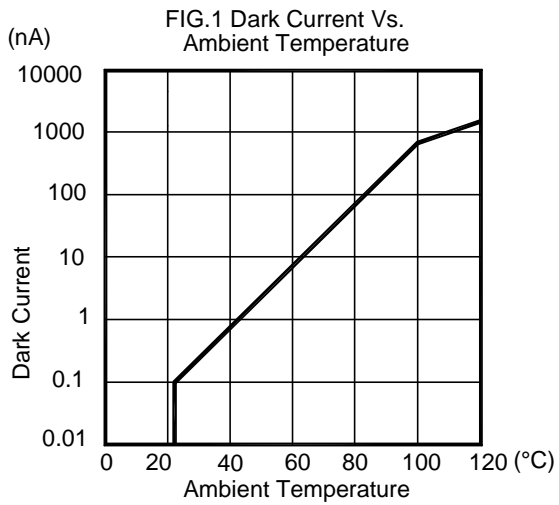

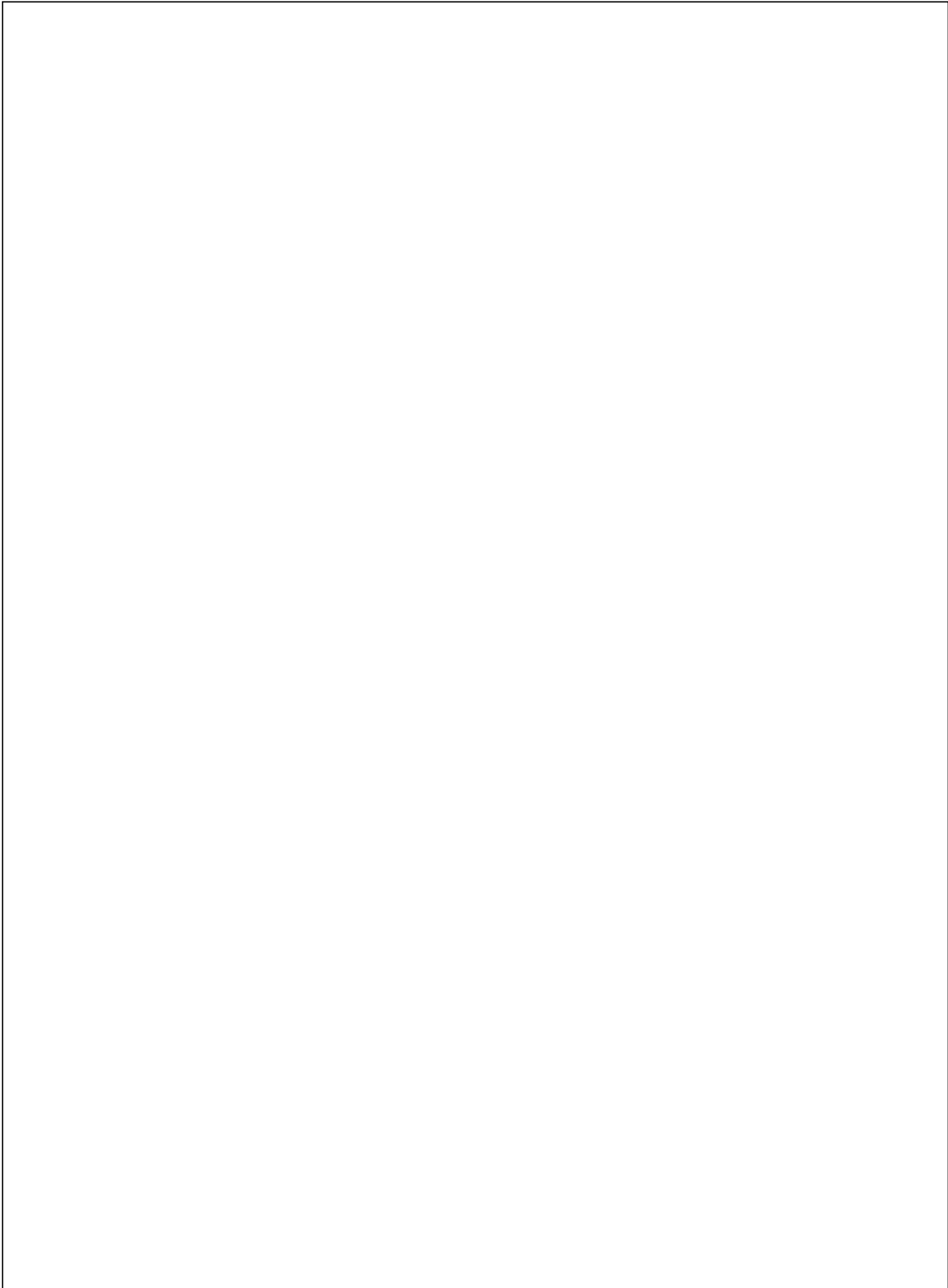

--	--	--	--

## Label Explanation

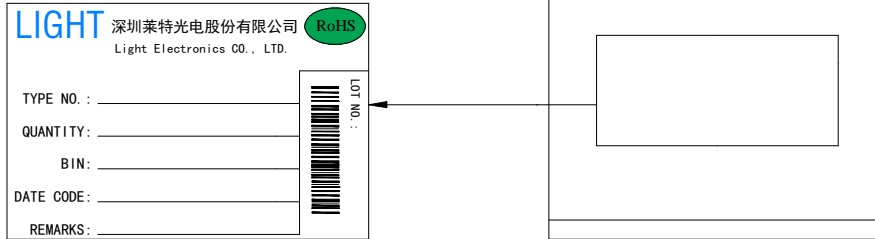

TYPE NO./	QUANTITY/
BIN./	DATE CODE/
REMARKS/	LOT NO./

## Reel Dimensions

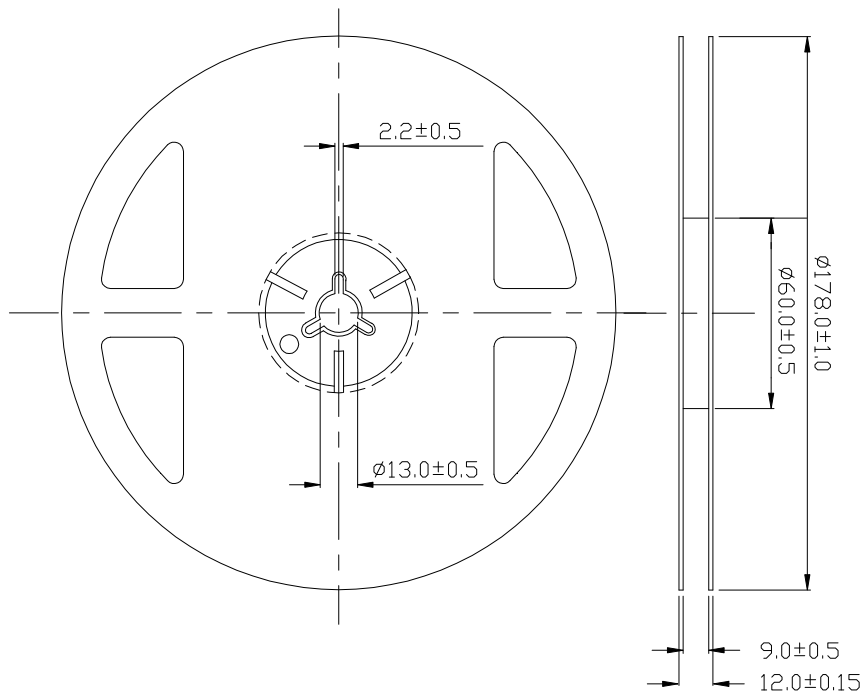

Tolerance unless mentioned is  $\pm 0.2\text{mm}$ ; Unit = mm





## Suggest IR Reflow Condition For Lead Free

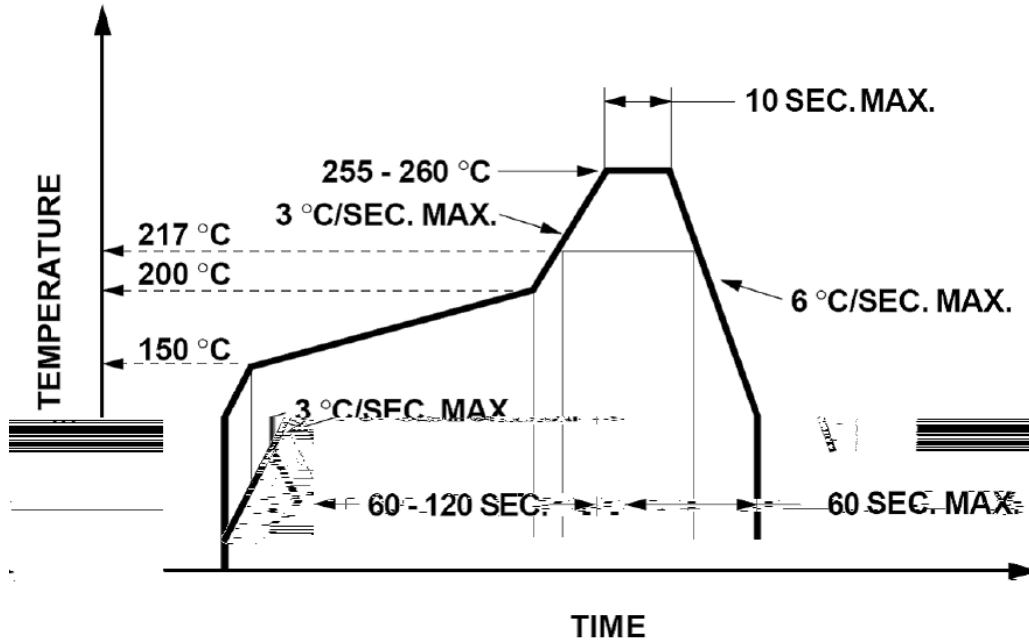

1. Reflow soldering should not be done more than two times.
2. When soldering, do not put stress on the LEDs during heating.

## Soldering iron

1. When hand soldering, the temperature of the iron must less than 350°C for 3 seconds.
2. The hand solder should be done only once.

## Repairing

Repair should not be done after the LEDs have been soldered. When repairing is unavoidable, a double-head soldering iron should be used (as below figure). It should be confirmed beforehand whether the characteristics of LEDs will or will not be damaged by repairing.

