

# **SL-T3528IR-850-1.4-R**

## **DATA SHEET**

SPEC. NO. : SZ20030501  
DATE : 2020/03/05  
REV. : A/1

Approved By:

Checked By:

Prepared By:

## Features

- Pb free product—RoHS compliant
- Low power consumption, High efficiency
- Reliable and rugged
- Long life – solid state reliability
- Radiant angle: 120°

## Package Dimension

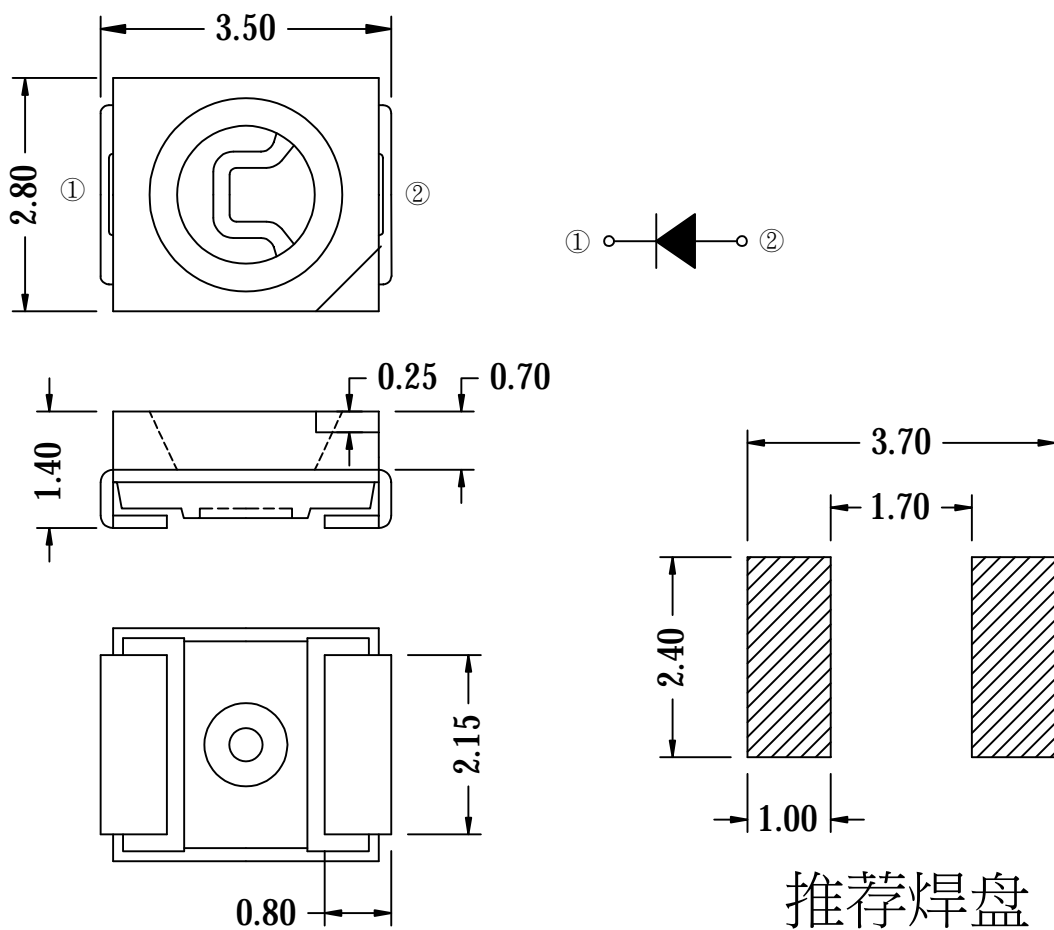

Part NO.	Chip Material	Lens Color
SL-T3528IR-850-1.4-R	AlGaAs/Si	Water Clear

### Notes:

1. All dimensions are in millimeters.
2. Tolerance is  $\pm 0.10$ mm unless otherwise noted
3. Specifications are subject to change without notice.

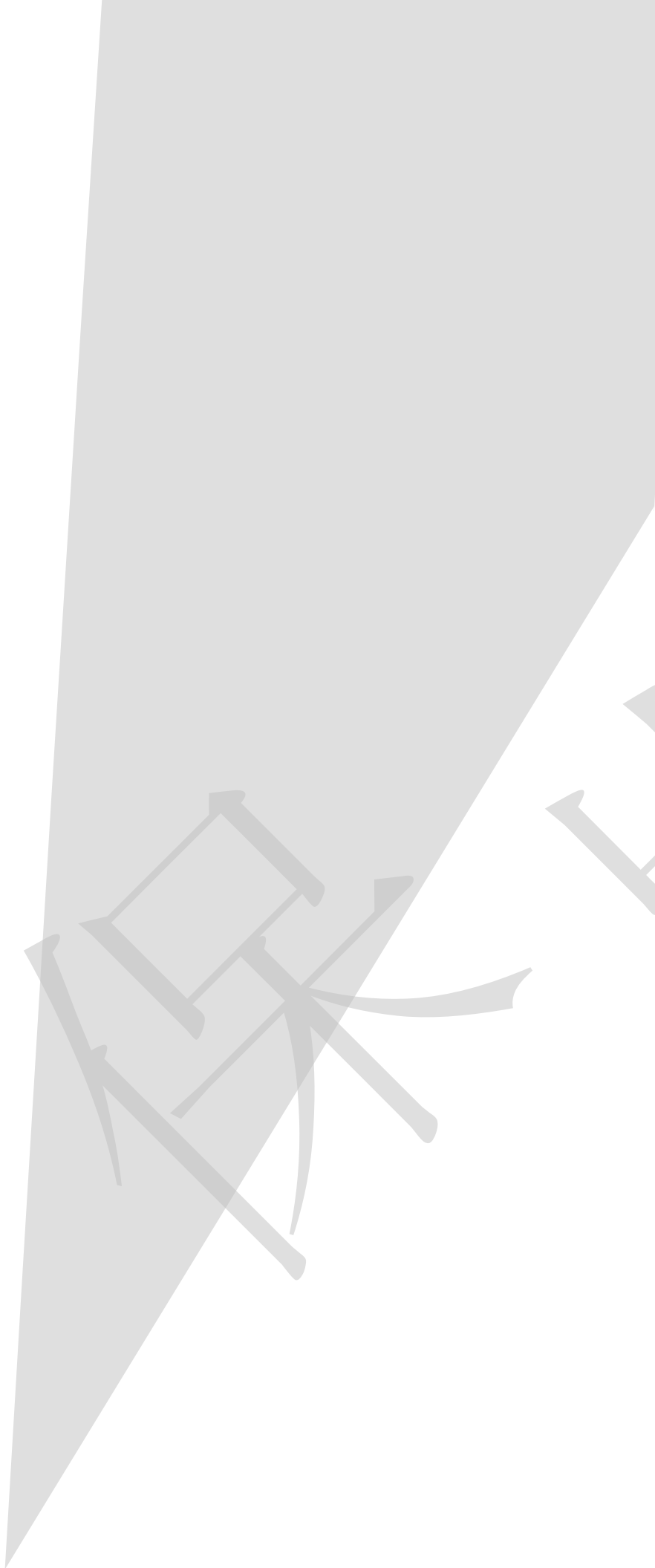



## Typical Electrical / Optical Characteristics Curves (25°C Ambient Temperature Unless Otherwise Noted)

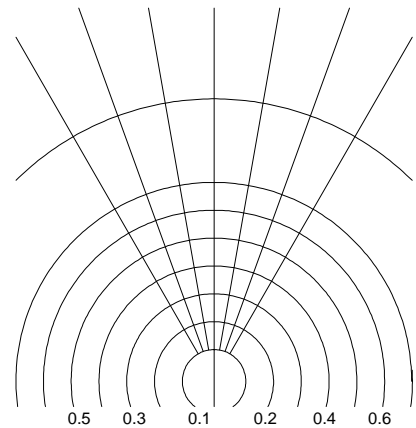
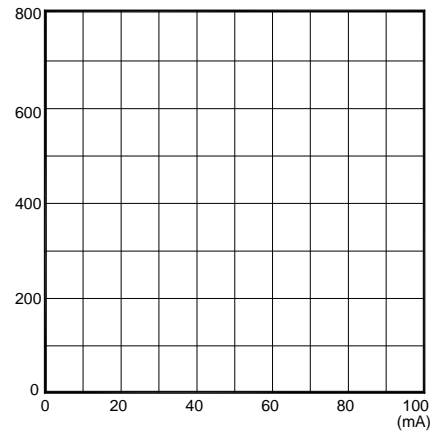
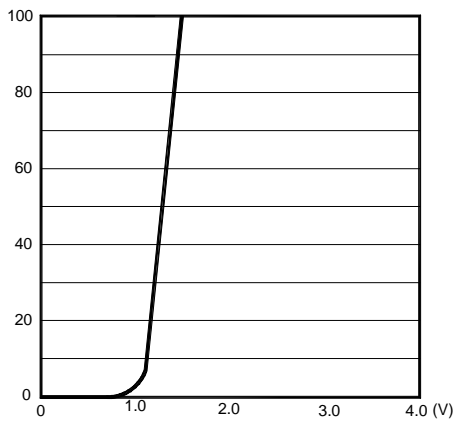
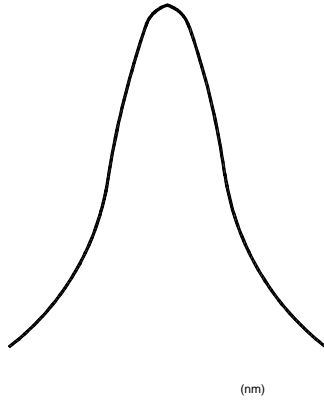



## Label Explanation

<b>LIGHT</b> Light Electronics CO., LTD.	
MODEL NAME: _____	 LOT NO. : _____
QUANTITY: _____	
BIN _____	
PACKING DATE: _____	
REMARKS: _____	

