

SL-T2016IRPTB009-L75

DATA SHEET

SPEC. NO. : SZ21073101
DATE : 2021/07/31
REV. : A/1

Approved By:

Checked By:

Prepared By:

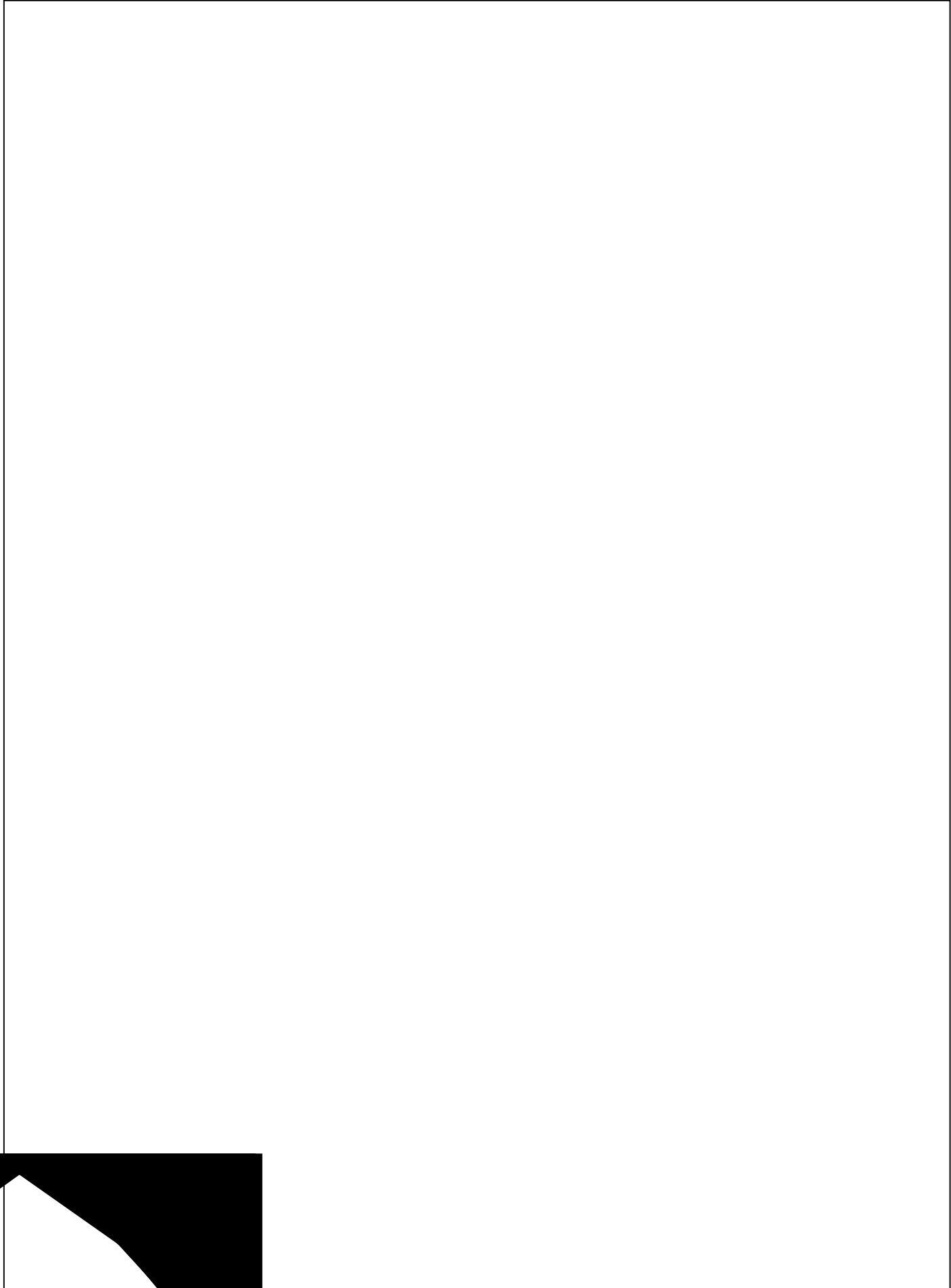

LIGHT for dehumidification.

2. Caution in ESD:

Static Electricity and surge damages the LED. It is recommend to use a wrist band or anti-electrostatic glove when handling the LED. All devices, equipment and machinery must be properly grounded.

3. Pulse Forward Current:

Pulse Width 0.1ms and duty 10%.

Typical Product Characteristics (Ta=25)-Emitter

Characteristics	Symbol	Min.	Typ.	Max.	Unit	Test condition
Forward Voltage	V_F	-	2.0	2.5	V	$I_F=7mA$
Reverse Current	I_R	-	-	10	μA	$V_R=2V$
Center Wavelength	λ_P	-	940	-	nm	$I_F=7mA$
Spectrum Width of Half Value	D_P	-	5	-	nm	$I_F=7mA$

Note: Tolerance of Forward Voltage: $\pm 0.1V$.

Typical Product Characteristics (Ta=25)-Detector

Characteristics	Symbol	Min.	Typ.	Max.	Unit	Test condition
Collector Emitter Breakdown Voltage	BV_{CEO}	85	-	-	V	$I_C=100\mu A$ $L^*=0$
Emitter Collector Breakdown Voltage	BV_{ECO}	8.2	-	-	V	$I_E=10\mu A$ $L^*=0$
Collector Emitter Dark Current	I_{CEO}	-	2	30	nA	$V_{CE}=20V, L^*=0$ Fig. 2

Note: $L^*=0$ (zero light condition)

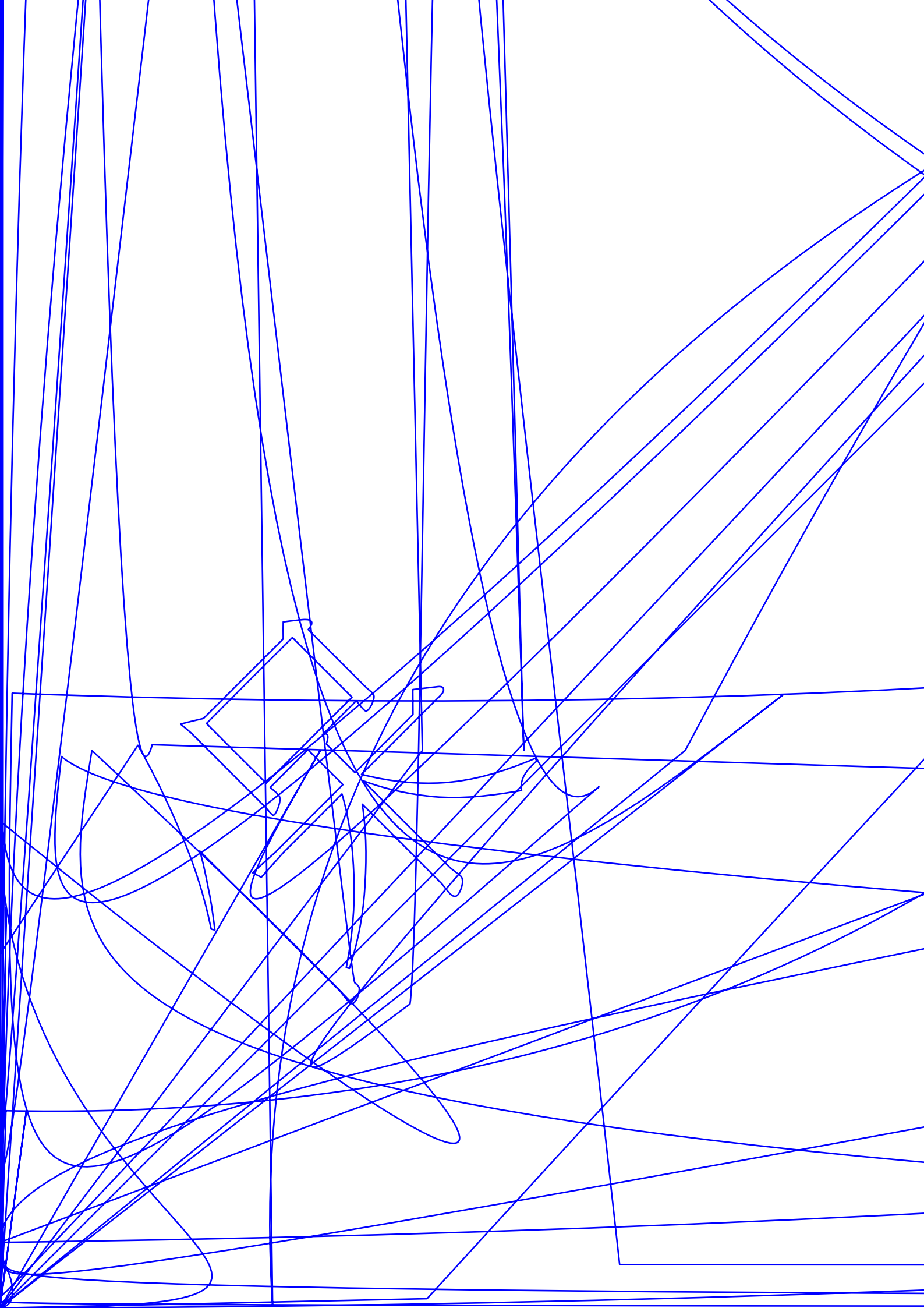

Optical Characteristics (Ta=25°C)

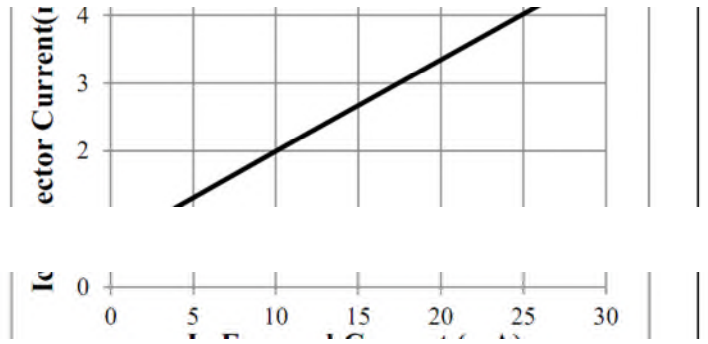
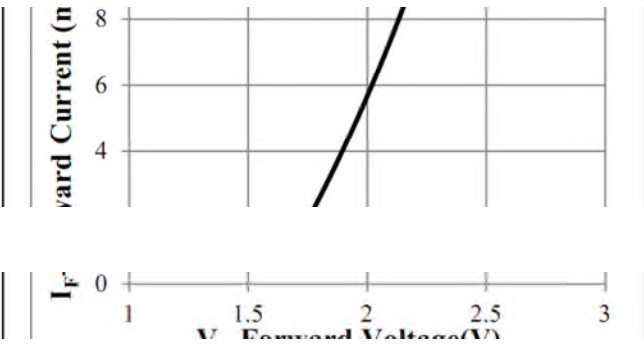

Note: $V_{CE}=5V$, $D=1\text{ms}$, Pulse width 0.1ms
5% Duty Cycle

3 Forward Voltage vs. Ambient Temperature

4 Collector Current vs. Ambient Temperature

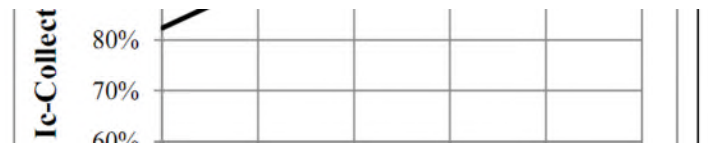
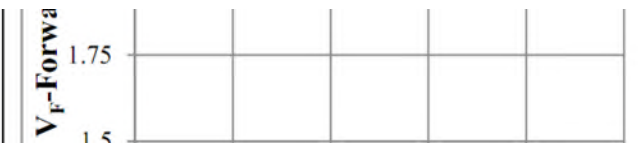

Output Current Test Condition (Ta=25°C)

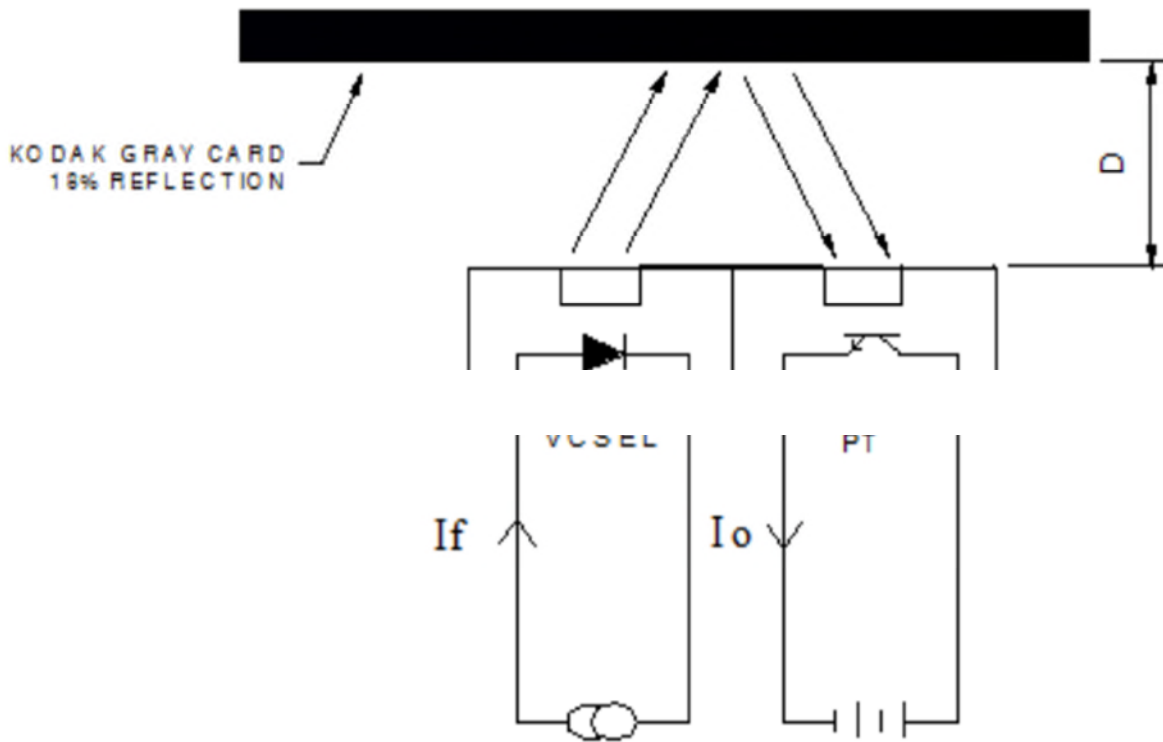

Fig.1 : Test Condition: D = 1mm 18% Gray Card, $I_F=7\text{ mA}$, $V_{CE} = 5\text{V}$, Pulse width 0.1ms, 5% Duty Cycle
Dark Current Test Condition (Ta=25°C)

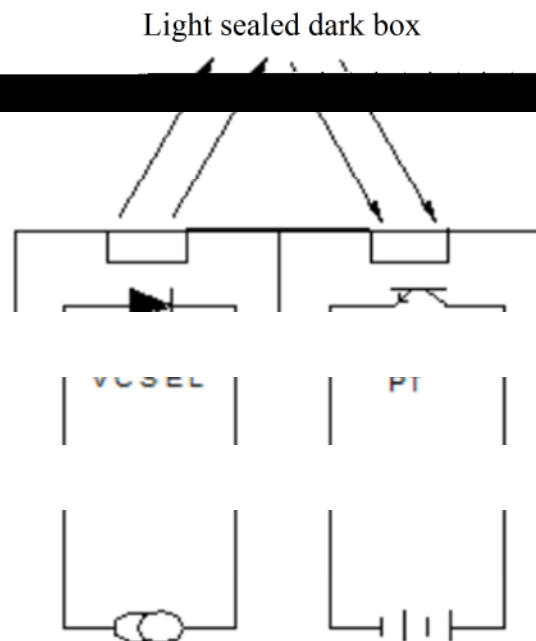
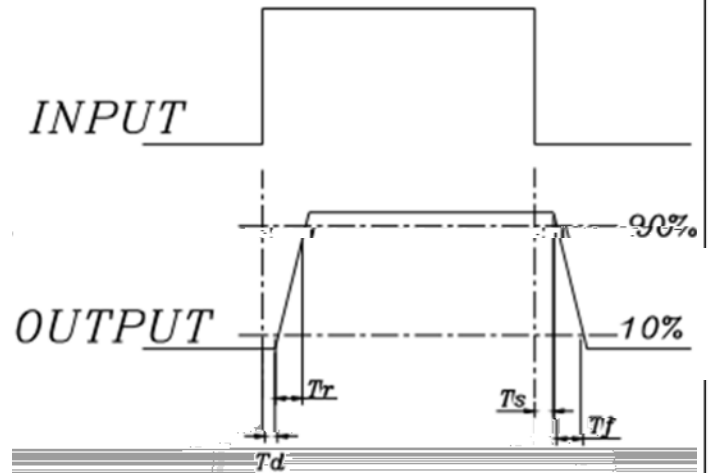
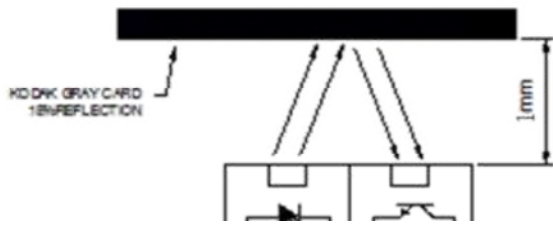

Fig. 2: Test Condition: $I_{LED}=9\text{ mA}$, $V_{CE} = 5\text{V}$, Pulse width 0.1ms, 5% Duty Cycle.

Dynamic Resistance Characteristics (Stray Inductance)



Label Explanation

LIGHT Universal Label
(Reel Label)

Customer Defined Label
(Aluminum Moisture Proof Bag Label)

LIGHT		
Light Electronics CO., LTD.		
MODEL NAME: _____	 LOT NO.: _____	
QUANTITY: _____		
BIN: _____		
PACKING DATE: _____		
REMARKS: _____		

LIGHT		
Light Electronics CO., LTD.		
MODEL NAME: _____	 LOT NO.: _____	
QUANTITY: _____		
BIN: _____		
PACKING DATE: _____		
CUSTOMER P/N: _____		

Reel Dimensions

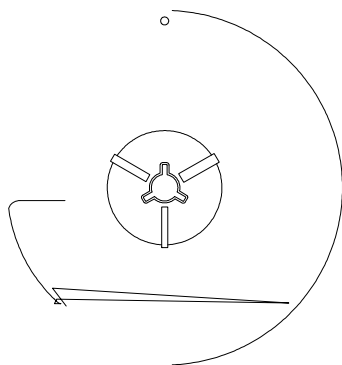

Note: Tolerance unless mentioned is ± 0.2 mm; Unit = mm



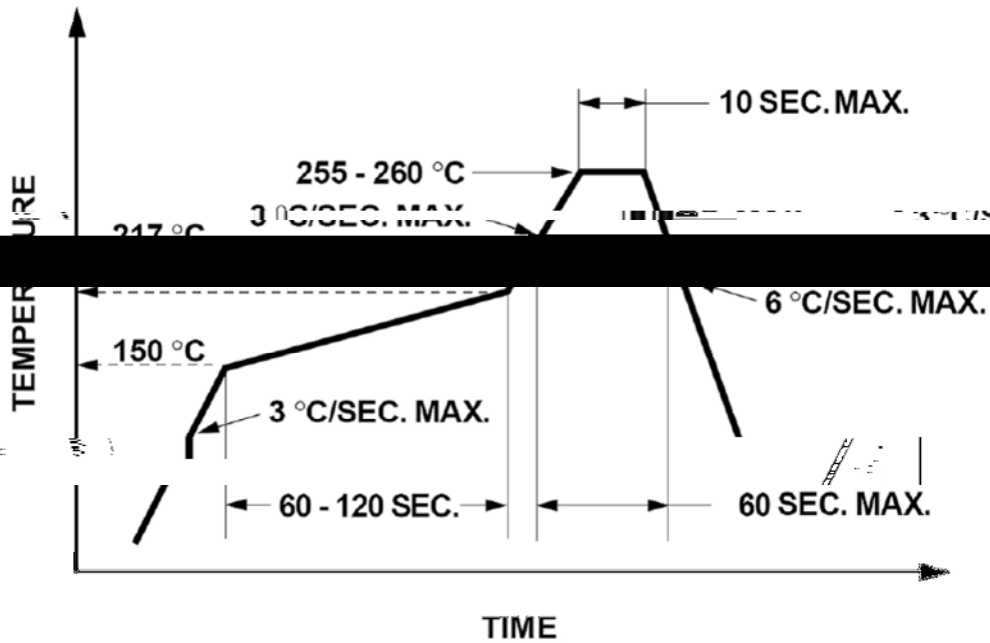

1. Reflow soldering should not be done more than two times.
2. When soldering, do not put stress on the LEDs during heating.

Soldering iron

1. When hand soldering, the temperature of the iron must less than 300°C for 3 seconds.
2. The hand solder should be done only once.

Repairing

~~Repair should not be done after the LEDs have been soldered. When repairing is unavoidable, a double-head soldering iron should be used (as below figure). It should be confirmed beforehand whether the characteristics of LEDs will or will not be damaged by repairing.~~

