

LIGHT

LIGHT ELECTRONICS CO., LTD.

Electro-Optical Characteristics





Electro-Optical Characteristics (Temperature=25°C)

以上 厂商

manufacturer

Typical Characteristics Curves

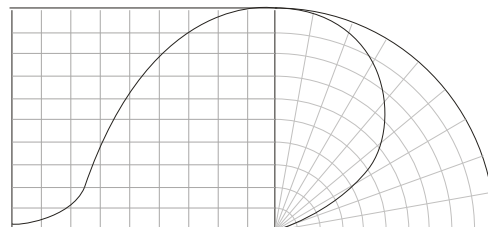
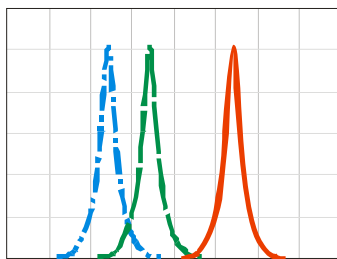
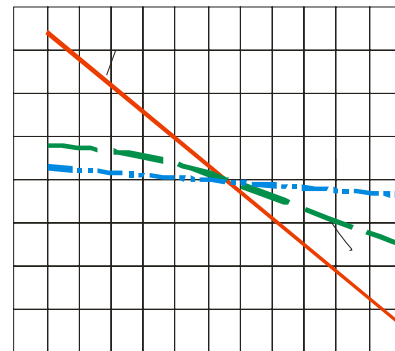
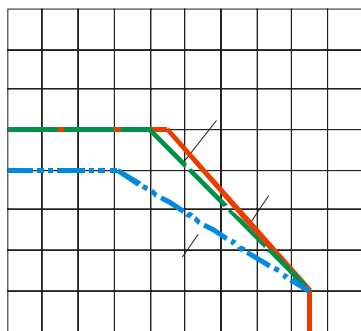
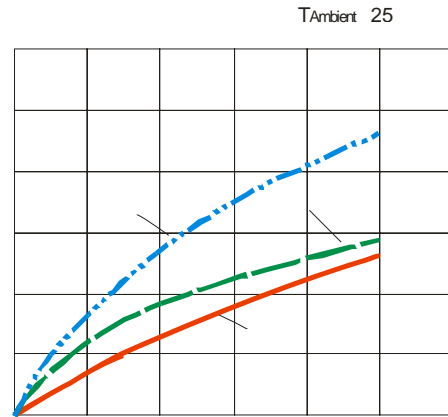
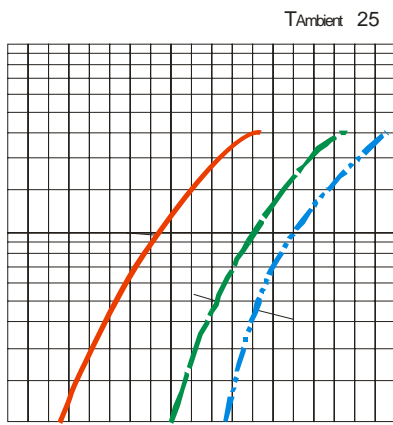

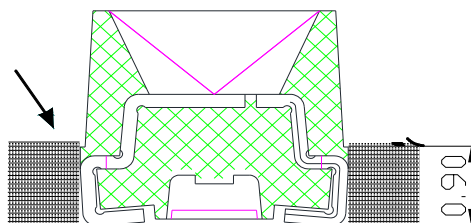

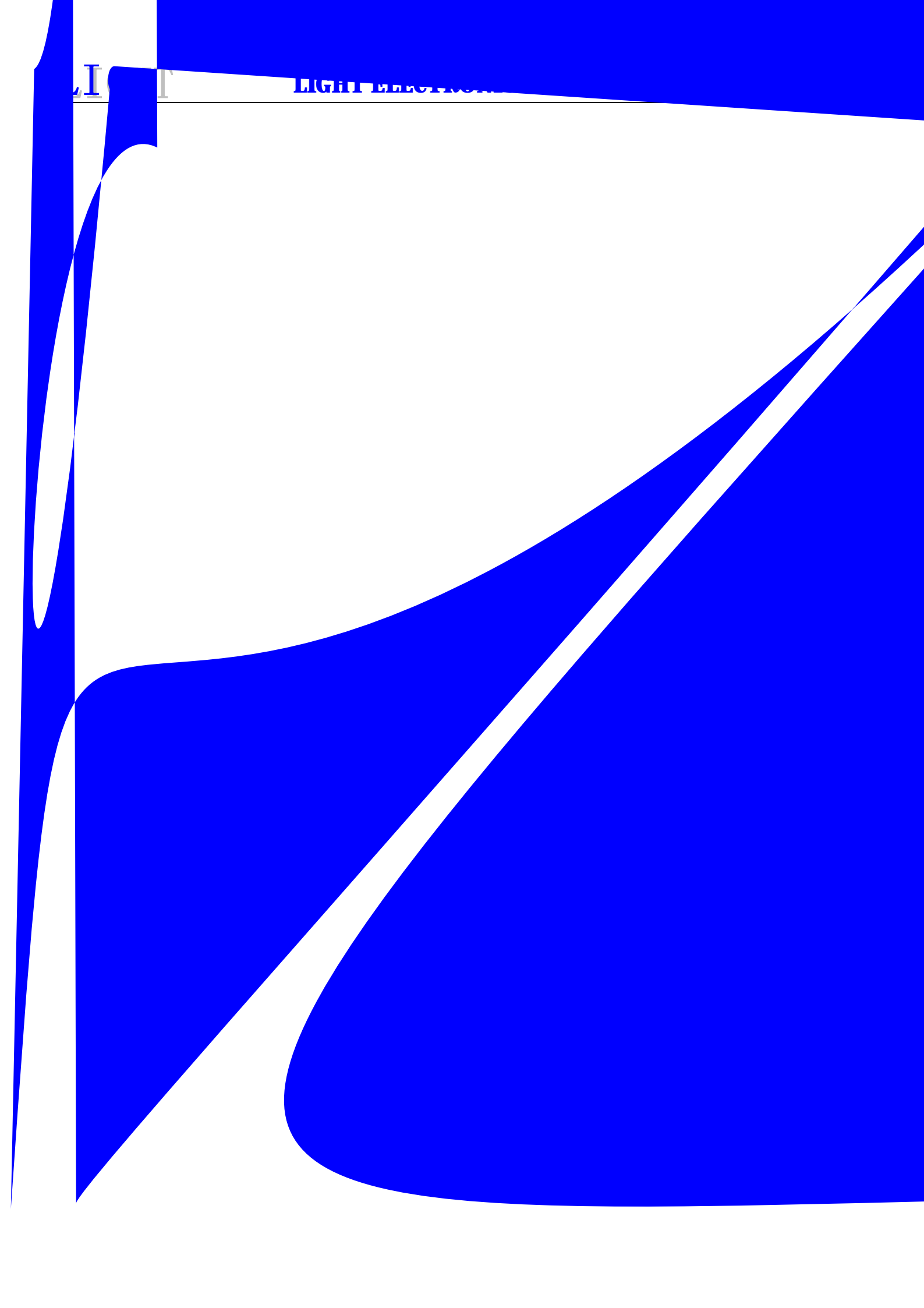

2

Packaging(2)



Moisture Proof and Anti-Electrostatic Foil Bag

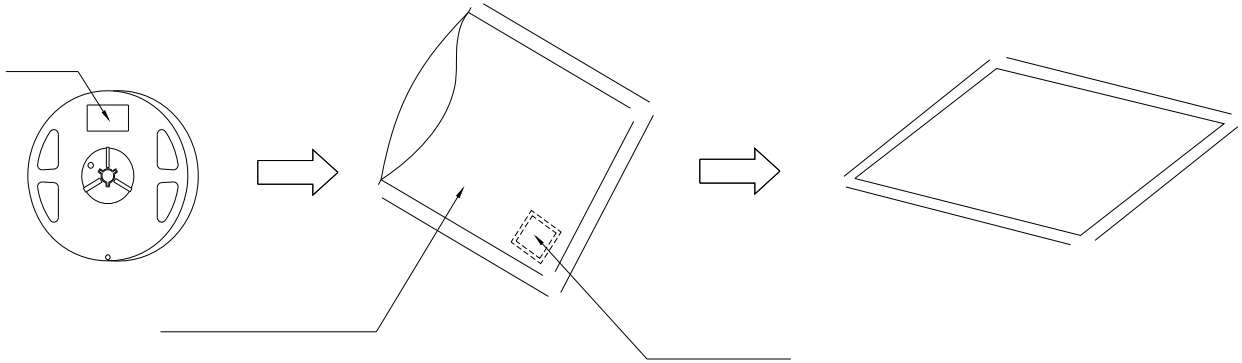

Cardboard Box



Label Explanation

L

LIGHT ELECTRONICS CO., LTD.

2

Guideline for Soldering (2)

3.

Cleaning

(1)

Precautions (1)

1.

Storage

-
-
-
-
-

2.

Static Electricity

-
-
-

(2)

Precautions (2)

3.

Design Consideration

•

•

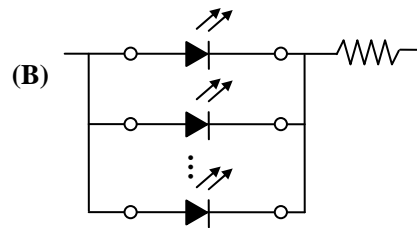
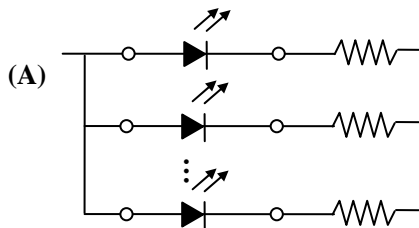

•

4.

Reverse voltage protection

•

•

(3)

Precautions (3)

5.

The safe temperature for LEDs working

-

6.

Others

-

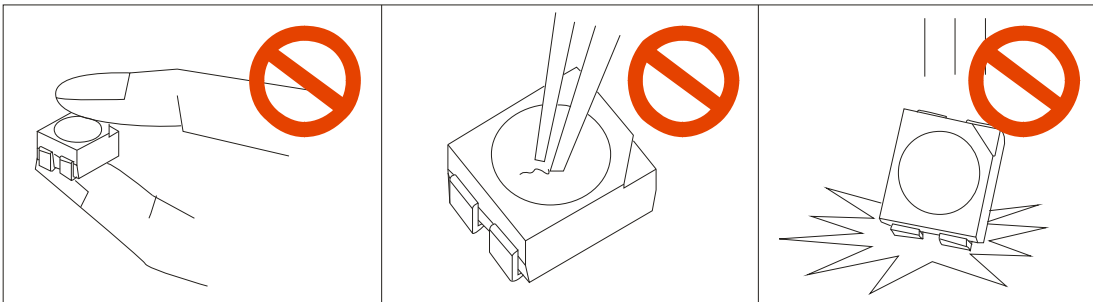

-